

TUBELESS-METALLVENTILE



aus vernickeltem Messing

11,5

Anzugsdrehmoment der Mutter: 3 bis 6 N.m.

Auch für LKW-Reifen Alu Michelin.

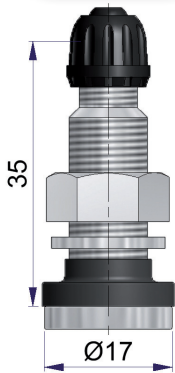

TR 416-S (V2.05.1)	Ersatzdichtung
S-4042-2	35440-68

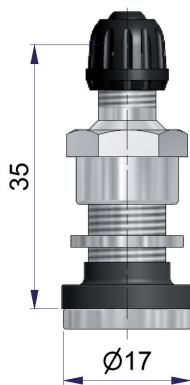

TR 416-S (V2.05.1)	Ersatzdichtung
S-4042-G	35440-68

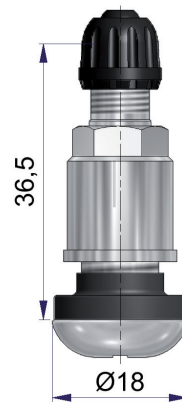

TR 416-S	Ersatzdichtung
42039-68	35440-68
42039-69	

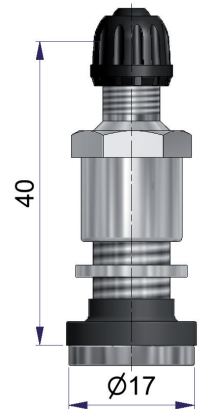

TR 416-S (V2.05.1)	Ersatzdichtung
S-4298-2	35440-68

aus Leichtlegierung (für Felgen mit Leichtlegierung)

Anzugsdrehmoment der Mutter: 10 bis 12 N.m.

Anzugsdrehmoment der Mutter: 7 bis 10 N.m.

11,5

MAX 210 km/h

11,5

9,7

8,5

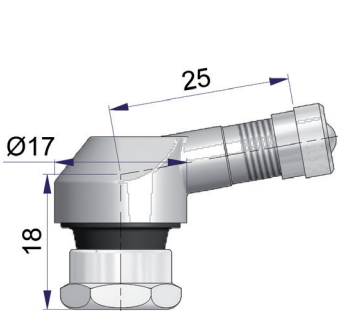

65252-68	Typ Motorrad gewinkelt
-----------------	------------------------

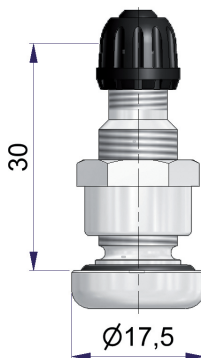

(V2.04.1)	Ersatzdichtung
R-1446-2	R-1524-2

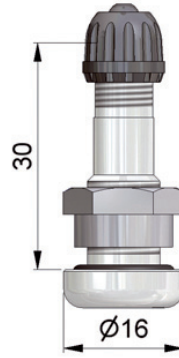

	Ersatzdichtung
R-1578-2	R-1419-2

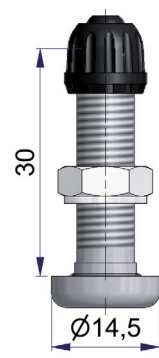

(V1.10.1)	Ersatzdichtung
Typ Motorrad	
R-1674-2	R-1709-2